



**URC 4080/4081
VIDEO EXPERT**



User's Guide

TABLE OF CONTENTS

Introduction	3
Features And Functions	4
Key Charts	5
Installing Batteries	7
Programming TV Control	8
Setup Codes for TVs	8
Programming VCR Control	12
Setup Codes for VCRs	12
Programming TV/VCR Combo Control	16
Setup Codes for TV/VCRs	17
Programming Cable Converter or Satellite Receiver Control	18
Setup Codes for Cable Converters	18
Setup Codes for Satellite Receivers	20
Programming DVD Player Control	21
Setup Codes for DVD Players	22
Setup Codes for LD Players	22
Searching For Your Code	23
Checking The Codes	24
Programming The Power Key	25
Re-Assigning Device Keys	26
Changing Volume Lock	27
To Change Volume Lock to the CBL/SAT Mode	27
To Change Volume Lock to the VCR Mode	27
To Change Volume Lock to the DVD Mode	27
To Change Volume Lock Back to the TV Mode	28
To Unlock Volume Lock	28
Using The Menu Key	28
Using Keymover	29
Using Macros	30
Programming a Favorite Channel	30
Programming a Secondary Master Power Key	31
Clearing a Macro	31
Using The Video Configuration Mode	32
An Example Video Configuration	33
Troubleshooting	35
Additional Information	36

INTRODUCTION

The One For All® 4-Device Video Expert remote control is our latest-generation universal remote control, designed specifically for controlling video components.

Its sophisticated technology will allow you to finally consolidate the clutter of the original remote controls in your home entertainment system. Moreover, it's packed with easy-to-use features such as:

- Preprogrammed technology for easy setup of video components in your home entertainment system
- Preprogrammable Master Power key for master on/off control of all of your equipment with a single keystroke
- A unique Video Configuration key that allow you to access home theater keys from various modes without changing device modes
- Keymover for mapping (copying) keys from one mode to another
- Menu function to navigate and choose on-screen menu items for a selected component
- User-programmed macro keys to perform repetitive, time-consuming operations for easy, convenient access through the press of a single key
- Color-coded keys to quickly locate popular functions
- Code library for video components
- Code Search to help program control of older or discontinued components

Before using your new remote control, you will need to program it to operate the specific home entertainment components you wish to control. Please follow the instructions detailed in this manual and then enjoy your new One For All 4-Device Video Expert remote control.

FEATURES AND FUNCTIONS

Use the illustration below to locate One For All 4-Device Video Expert remote control features and then study the *Key Charts* (on the next two pages) to learn how they function.

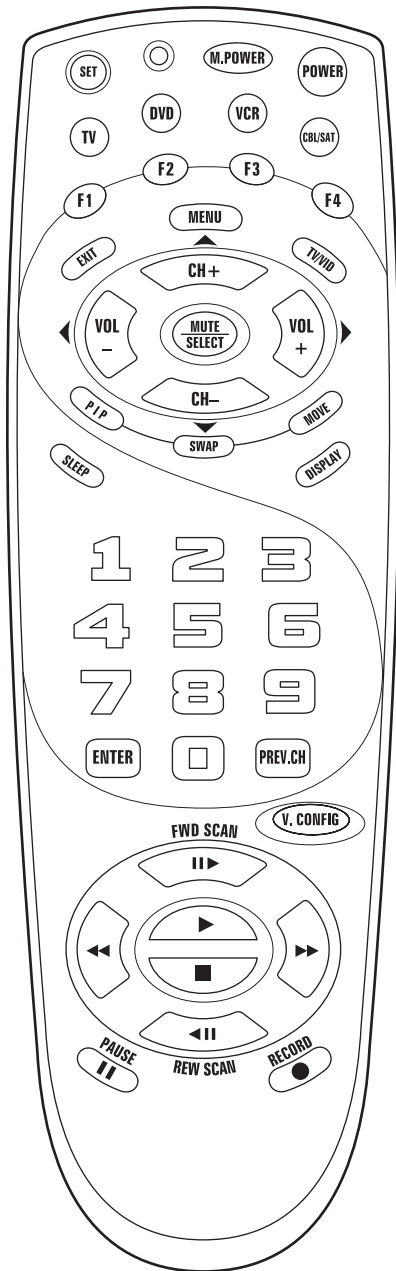



Key Charts

-  Use SET for all programming sequences.

-  The LED (red light) blinks to show that the remote control is working and is sending signals.

-  Use M.POWER to set up and turn on (or off) all your video components with a single key. Also see page 25.

-  Press POWER once to turn on (or off) a selected home entertainment component.

-  Press TV, DVD, VCR, or CBL/SAT once to select a home entertainment video component to control.

-  Use the F1, F2, F3, or F4 keys to program macros. Also see page 30.

-  Use EXIT to exit out of your cable converter's menu and guide.

-  Press MENU once to display the selected component's screen menu. Use the VOL +/- and CH +/- keys to navigate menus and press the MUTE key to select items.

-  Press TV/VID to switch viewing between TV and video sources.

-  Use VOL + (or VOL -) to raise (or lower) the sound volume.

-  Use CH + (or CH -) to select the next higher (or lower) channel.

-  Press MUTE/SELECT once to turn sound off or on. Also, use MUTE/SELECT to select items from the selected component's screen menu after pressing MENU once.

-  After pressing MENU, use the Cursor Keys to move the cursor in the program guide and menu screens.

continued on next page...

FEATURES AND FUNCTIONS

Key Charts (Continued)



Press PIP once to view or turn off the picture-in-picture feature.



Press SWAP once to exchange the PIP with the main TV picture.



Use MOVE to the picture-in-picture position on the TV screen.



Press SLEEP once to enable (or disable) a selected component's sleep timer (if available).



Use DISPLAY to view a selected component's information on the TV.

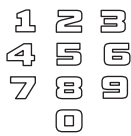

Use the keypad (0 ~ 9) to directly select channels (e.g., 09 or 31).



Press ENTER once after entering channel numbers on some TV models.



Press PREV.CH once to recall the last-viewed channel.



Use V.CONFIG to custom program and recall video configuration modes for home theater use. Also see page 32.

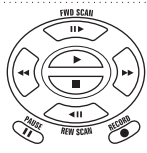

In the TV, DVD, or VCR mode, use the FWD SCAN, REW SCAN, PLAY, STOP, and PAUSE keys to control your VCR or DVD (or LD) player. To record a program on the VCR, press REC twice.

INSTALLING BATTERIES

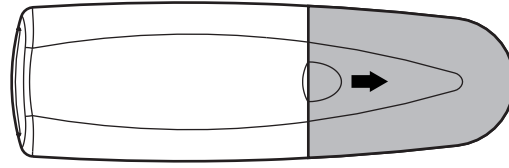

1

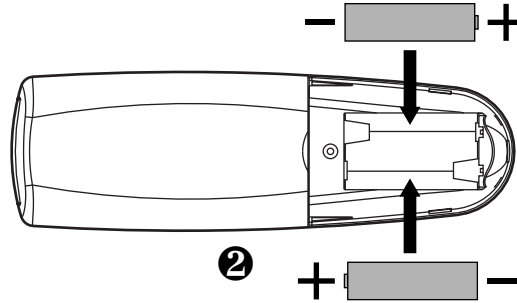

2

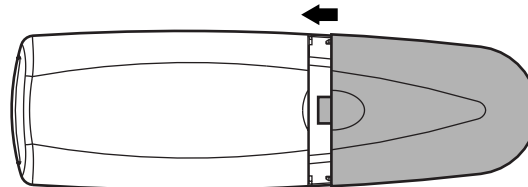

3

1. On the back of the remote control, press the recess and slide the battery cover off (see above).
2. Obtain two (2) fully-charged AA alkaline batteries. Match the + and - marks on the batteries to the + and - marks in the battery case, then insert the new batteries.
3. Align the cover keys with the case openings and slide the cover on until it locks.
4. Test the unit by pressing POWER and any mode key (e.g. TV, DVD, VCR, or CBL/SAT). If batteries are inserted correctly, the LED will blink once.

NOTE: When batteries need replacement, the One For All 4-Device Video Expert remote control will cease to operate. Simply replace the batteries and the unit will be restored to its full functionality, complete with your favorite settings.

PROGRAMMING TV CONTROL

NOTE: If you own a TV/VCR combination, skip this section and perform "Programming TV/VCR Combo Control" on page 16.

Locate the brand name of your TV in the *Setup Codes For TVs* section below, and write it in the following space.

TV Brand: _____

The brands are listed in alphabetical order with the most popular codes listed first. To program TV control:

1. Turn on the TV.
2.  On the remote control, press TV once. Press and hold SET until the LED blinks twice, then release SET.

NOTE: The remote control will exit programming if more than 10 seconds elapse between key presses.

3. Enter the first four-digit code for your TV. If you perform this procedure correctly, the LED will blink twice.

NOTE: If the LED emits a long blink, the code is invalid. Repeat steps 2 through 3 and try entering the same code again.

4.  Aim the remote control at your TV and press POWER once. The TV should turn off. If it does not respond, repeat steps 2-3, trying each code for your brand until you find one that works. If it still does not work, try searching for the code (see *Searching For Your Code* on page 23).

5. Write your TV code in the boxes below for future reference.

--	--	--	--

NOTE: Remember, to use the One For All 4-Device Video Expert remote control to operate your TV, press TV first.

Setup Codes for TVs:

AOC	0030, 0019, 0052
Admiral	0093, 0463
Aiko	0092
Akai	0030
Alaron	0179
Ambassador	0177
America Action	0180

Ampro	0751
Anam	0180
Audiovox	0451, 0180, 0092, 0623
Baysonic	0180
Belcor	0019
Bell & Howell	0154
Bradford	0180
Brockwood	0019
Broksonic	0236, 0463
CXC	0180
Candle	0030, 0056
Carnivale	0030
Carver	0054
Celebrity	0000
Cineral	0451, 0092
Citizen	0060, 0030, 0056, 0039, 0092
Concerto	0056
Contec	0180
Craig	0180
Crosley	0054
Crown	0180, 0039
Curtis Mathes	0047, 0054, 0154, 0051, 0451, 0093, 0060, 0030, 0145, 0056, 0039, 0166, 0466, 1147, 1347
Daewoo	0451, 0019, 0039, 0092, 0623, 0624
Daytron	0019
Denon	0145
Dumont	0017, 0019
Dwin	0720, 0774
Electroband	0000
Emerson	0154, 0236, 0463, 0180, 0178, 0019, 0179, 0039, 0177, 0623, 0624
Envision	0030
Fisher	0154
Fujitsu	0179, 0683
Funai	0180, 0179, 0171
Futuretech	0180
GE	0047, 0051, 0451, 0093, 0178, 0135, 1147, 1347
Gibraltar	0017, 0030, 0019
GoldStar	0030, 0178, 0019, 0056
Gradiente	0053, 0056
Grunpy	0180, 0179
Hallmark	0178
Harley Davidson	0179
Harman/Kardon	0054
Harvard	0180
Hitachi	0145, 0056, 0151
Infinity	0054
Inteq	0017
JBL	0054
JCB	0000
JVC	0053

continued on next page...

PROGRAMMING TV CONTROL

Setup Codes for TVs (Continued):

KEC	0180
KTV	0180, 0030, 0039
Kaypani	0052
Kenwood	0030, 0019
LG	0056
LXI	0047, 0054, 0154, 0156, 0178
Luxman	0056
MGA	0150, 0030, 0178, 0019
MTC	0060, 0030, 0019, 0056
Magnavox	0054, 0030, 0179, 1254
Marantz	0054, 0030
Matsushita	0250
Megatron	0178, 0145
Memorex	0154, 0250, 0463, 0150, 0178, 0056
Midland	0047, 0017, 0051, 0039, 0135
Mitsubishi	0093, 0150, 0178, 0019
Motorola	0093
Multitech	0180
NAD	0156, 0178, 0166
NEC	0030, 0019, 0056
NTC	0092
Nikko	0030, 0178, 0092
Onwa	0180
Optimus	0154, 0250, 0166
Optonica	0093, 0165
Orion	0236, 0463, 0179
Panasonic	0051, 0250
Penney	0047, 0156, 0051, 0060, 0030, 0178, 0019, 0056, 0039, 0135, 1347
Philco	0054, 0463, 0030, 0145, 0019
Philips	0054
Pilot	0030, 0019, 0039
Pioneer	0166
Portland	0019, 0039, 0092
Prism	0051
Proscan	0047
Proton	0178, 0031, 0052, 0466
Pulsar	0017, 0019
Quasar	0051, 0250, 0165
RCA	0047, 0051, 0093, 0019, 0090, 0135, 1047, 1147, 1247, 1347, 1447
Radio Shack	0047, 0154, 0165, 0180, 0030, 0178, 0019, 0056, 0039
Realistic	0154, 0165, 0180, 0030, 0178, 0019, 0056, 0039
Runco	0017, 0030
SSS	0180, 0019
Sampo	0030, 0039, 0052
Samsung	0060, 0030, 0178, 0019, 0056
Samsux	0039

Sansei	0451
Sansui	0463
Sanyo	0154
Scimitsu	0019
Scotch	0178
Scott	0236, 0180, 0178, 0019, 0179
Sears	0047, 0054, 0154, 0156, 0178, 0179, 0056, 0171
Semivox	0180
Semp	0156
Sharp	0093, 0165, 0039
Shogun	0019
Sony	0000
Soundesign	0180, 0178, 0179
Squareview	0171
Starlite	0180
Supreme	0000
Sylvania	0054, 0030
Symphonic	0171
TMK	0178, 0056, 0177
Tandy	0093
Technics	0051, 0250
Technol Ace	0179
Techwood	0051, 0056
Teknika	0054, 0180, 0150, 0060, 0019, 0179, 0056, 0039, 0092
Telefunken	0056
Tera	0031
Toshiba	0154, 0156, 0060, 1256
Totevision	0039
Vector Research	0030
Victor	0053
Vidikron	0054
Vidtech	0178, 0019
Wards	0054, 0165, 0030, 0178, 0019, 0179, 0056
White Westinghouse	0463, 0623, 0624
Yamaha	0030, 0019
Zenith	0017, 0463, 0092, 0624

PROGRAMMING VCR CONTROL



NOTE: If you own a TV/VCR combination, skip this section and perform "Programming TV/VCR Combo Control" on page 16.

Locate the brand name of your VCR in the *Setup Codes For VCRs* section below, and write it in the following space.

VCR Brand: _____

The brands are listed in alphabetical order with the most popular codes listed first. To program VCR control:

1. Turn on your VCR and insert a video cassette.

2.  On the remote control, press VCR once. Press and hold SET until the LED blinks twice, then release SET.

NOTE: The remote control will exit programming if more than 10 seconds elapse between key presses.

3. Enter the first four-digit code for your VCR. If you perform this procedure correctly, the LED will blink twice.

NOTE: If the LED emits a long blink, the code is invalid. Repeat steps 2 through 3 and try entering the same code again.

4.  Aim the remote control at your VCR and press POWER once. The VCR should turn off. If your VCR remote control does not have a POWER key, press PLAY. If the VCR does not respond, repeat steps 2-3, trying each code listed for your brand until you find one that works. If the VCR still does not work, try searching for the code (see *Searching For Your Code* on page 23).

5. Write your VCR code in the boxes below for future reference.

--	--	--	--

NOTE: Remember, to use the One For All 4-Device Video Expert remote control to operate your VCR, press VCR first.

Setup Codes for VCRs:

Admiral	0048, 0209
Adventura	0000
Aiko	0278
Aiwa	0037, 0000
Akai	0041

America Action	0278
American High	0035
Asha	0240
Audiovox	0037
Beaumarck	0240
Bell & Howell	0104
Broksonic	0184, 0121, 0209, 0002, 0479
CCE	0072, 0278
Calix	0037
Canon	0035
Carver	0081
Cineral	0278
Citizen	0037, 0278
Colt	0072
Craig	0037, 0047, 0240, 0072, 0271
Curtis Mathes	0060, 0035, 0041, 0162
Cybernex	0240
Daewoo	0045, 0278
Denon	0042
Dynatech	0000
Electrohome	0037
Electroponic	0037
Emerex	0032
Emerson	0037, 0184, 0000, 0121, 0043, 0209, 0002, 0278, 0479
Fisher	0047, 0104
Fuji	0035, 0033
Funai	0000
GE	0060, 0035, 0048, 0202, 0240
Garrard	0000
Go Video	0526
GoldStar	0037, 0038
Gradiente	0000
HI-Q	0047
Harley Davidson	0000
Harman/Kardon	0081, 0038
Harwood	0072
Hitachi	0000, 0042, 0041
Hughes Network	0042
JVC	0067, 0041
Jensen	0041
KEC	0037, 0278
KLH	0072
Kenwood	0067, 0041, 0038
Kodak	0035, 0037
LXI	0037
Lloyd's	0000
Logik	0072
MEI	0035
MGA	0240, 0043
MGN Technology	0240
MTC	0240, 0000

continued on next page...

PROGRAMMING VCR CONTROL

Setup Codes for VCRs (Continued):

Magnasonic	0278
Magnavox	0035, 0039, 0081, 0000, 0149
Magnin	0240
Marantz	0035, 0081
Marta	0037
Matsushita	0035, 0162, 0454
Memorex	0035, 0037, 0048, 0039, 0047, 0240, 0000, 0104, 0209, 0454, 1037, 1162, 1262
Minolta	0042
Mitsubishi	0048, 0067, 0043
Motorola	0035, 0048
Multitech	0000, 0072
NEC	0104, 0067, 0041, 0038
Nikko	0037
Noblex	0240
Olympus	0035
Optimus	0037, 0048, 0104, 0162, 0454, 1048, 1062, 1162, 1262
Orion	0184, 0209, 0002, 0479
Panasonic	0035, 0162, 0225, 0454, 0616, 1062, 1162, 1262
Penney	0035, 0037, 0240, 0042, 0038
Pentax	0042
Philco	0035, 0209, 0479
Philips	0035, 0081, 0618
Pilot	0037
Pioneer	0067
Profitronic	0240
Proscan	0060, 0202
Protec	0072
Pulsar	0039
Quasar	0035, 0162, 0454, 1162
RCA	0060, 0035, 0048, 0240, 0042, 0149, 0202
Radio Shack	0000, 1037
Radix	0037
Randex	0037
Realistic	0035, 0037, 0048, 0047, 0000, 0104
ReplayTV	0614, 0616
Runco	0039
STS	0042
Samsung	0240, 0045
Sanky	0048, 0039
Sansui	0000, 0067, 0209, 0041, 0271, 0479
Sanyo	0047, 0240, 0104
Scott	0184, 0045, 0121, 0043
Sears	0035, 0037, 0047, 0000, 0042, 0104
Semp	0045
Sharp	0048
Shintom	0072
Shogun	0240



Singer	0072
Sony	0035, 0032, 0000, 0033
Sylvania	0035, 0081, 0000, 0043
Symphonic	0000
TMK	0240
Tatung	0041
Teac	0000, 0041
Technics	0035, 0162, 0202
Teknika	0035, 0037, 0000
Thomas	0000
Tivo	0618
Toshiba	0045, 0043
Totevision	0037, 0240
Unitech	0240
Vector	0045
Vector Research	0038
Video Concepts	0045
Videosonic	0240
Wards	0060, 0035, 0048, 0047, 0081, 0240, 0000, 0042, 0072, 0149
White Westinghouse	0209, 0278
XR-1000	0035, 0000, 0072
Yamaha	0038
Zenith	0039, 0000, 0209, 0033, 0479

PROGRAMMING TV/VCR COMBO CONTROL

Locate the brand name of your TV/VCR Combo in the *Setup Codes For TV/VCR Combos* section on the next page, and write it in the following space.

TV/VCR Combo Brand: _____



The brands are listed in alphabetical order with the most popular codes listed first. To program TV/VCR control:

1. Turn on your TV/VCR Combo and insert a video cassette.
2.  On the remote control, press VCR once. Press and hold  until the LED blinks twice, then release SET.

NOTE: The remote control will exit programming if more than 10 seconds elapse between key presses.
3. Enter the first four-digit code for your TV/VCR Combo. If you perform this procedure correctly, the LED will blink twice.

NOTE: If the LED emits a long blink, the code is invalid. Repeat steps 2 through 3 and try entering the same code again.
4.  Aim the remote control at your TV/VCR Combo and press POWER once. The unit should turn off. If it does not respond, repeat steps 2-3, trying each code listed for your brand until you find one that works. If it still does not work, try searching for the code (see *Searching For Your Code* on page 23).
5. If you've located a TV/VCR setup code that works your TV/VCR Combo and a separate TV code is also listed, you'll need to program this code into the remote control to access volume control (see *Programming TV Control* on page 8).

If there is no separate TV code listed, you will need to perform the following steps to access volume control:

 - a.  Press and hold SET until the LED blinks twice, then release SET.
 -  b. Enter 9 - 9 - 3. The LED will blink twice.
 -  c. Press VCR once. The LED will blink twice.

6. Write your TV/VCR Combo code in the boxes below for future reference.

--	--	--	--

NOTE: Remember, to use the One For All 4-Device Video Expert to operate your TV/VCR Combo, press VCR first.

Setup Codes for TV/VCR Combos:

Brocksonic	0002, 0479 (TV:0463)
Citizen	0278
Colt	0072
Curtis Mathes	0035 (TV:0051)
Daewoo	0278 (TV:0624)
Emerson	0002, 0479 (TV:0463), 0278 (TV:0624)
Funai	0000
GE	0060 (TV:0047), 0048 (TV:0093), 0035 (TV:0051), 0240
GoldStar	0037 (TV:0056)
Harley Davidson	0000
Hitachi	0000
Lloyd's	0000
Magnasonic	0278
Magnavox	0000, 0081 (TV:0054)
Magnin	0240
Memorex	1162, 1262, 0162 (TV:0250), 0037 (TV:0056), 1037
MGA	0240
Mitsubishi	0048 (TV:0093)
Optimus	1162, 1262, 0162 (TV:0250)
Orion	0002, 0479 (TV:0463)
Panasonic	1162, 1262, 0162 (TV:0250), 0035 (TV:0051)
Penney	0037 (TV:0056), 0035 (TV:0051), 0240
Quasar	0162 (TV:0250), 0035 (TV:0051)
Radio Shack	1037
RCA	0060 (TV:0047), 0048 (TV:0093), 0035 (TV:0051), 0240
Sansui	0000, 0479 (TV:0463)
Sanyo	0240
Sears	0000, 0037 (TV:0056)
Sharp	0048 (TV:0093)
Sony	0032 (TV:0000)
Sylvania	0081 (TV:0054)
Symphonic	0000
Thomas	0000
White Westinghouse	0278 (TV:0624)
Zenith	0000, 0479 (TV:0463)

PROGRAMMING CABLE CONVERTER OR SATELLITE RECEIVER CONTROL

Locate the brand name of your Cable Converter or Satellite Receiver in the setup codes section starting below, and write it in the appropriate space.

Cable Converter Brand: _____
or
Satellite Receiver Brand: _____

The brands are listed in alphabetical order with the most popular codes listed first. To program component control:

1. Turn on the Cable Converter or Satellite Receiver.

2.  On the remote control, press CBL/SAT once. Press and hold SET until the LED blinks twice, then release SET.

NOTE: The remote control will exit programming if more than 10 seconds elapse between key presses.

3. Enter the first four-digit code for your Cable Converter or Satellite Receiver. If performed correctly, the LED will blink twice.

NOTE: If the LED emits a long blink, the code is invalid. Repeat steps 2 through 3 and try entering the same code again.

4.  Aim the remote control at your Cable Converter or Satellite Receiver and press POWER once. The unit should turn off. If it does not respond, repeat steps 2-3, trying each code listed for your brand until you find one that works. If it still does not work, try searching for the code (see page 23).

5. Write your Cable Converter or Satellite Receiver code in the boxes below for future reference.

--	--	--	--

NOTE: Remember, to use the One For All 4-Device Video Expert remote control to operate your Cable Converter or Satellite Receiver, press CBL/SAT first.

Setup Codes for Cable Converters:

ABC	0003, 0008, 0014, 0017, 0007, 0011, 0013
Allegro	0153, 0315
Americast	0899
Antronix	0022

Archer	0153, 0022, 0797
Belcor	0056
Bell & Howell	0014
Bell South	0899
Cable Star	0056
Cabletenna	0022
Cableview	0022
Century	0153
Citizen	0153, 0315
Colour Voice	0025
Comtronics	0040
Contec	0019
Digi	0637
Eastern	0002
Emerson	0797
Everquest	0015, 0040
Focus	0400
GC Electronics	0056
Garrard	0153
Gemini	0015, 0797
General Instrument	0476, 0276, 0011, 0810
GoldStar	0144, 0040
Goodmind	0797
Hamlin	0020, 0259, 0009, 0034
Hitachi	0011
Hytex	0007
Jasco	0015, 0153, 0315
Jerrold	0003, 0012, 0476, 0276, 0014, 0015, 0011, 0810
Linsay	0440
Memorex	0000
Movie Time	0063
NSC	0063
Novaplex	0618
Oak	0019, 0007
Optimus	0021
Panasonic	0000, 0107, 0021
Panther	0637
Paragon	0000
Phillips	0153, 0025
Pioneer	0144, 0533, 0877
Popular Mechanics	0400
Pulsar	0000
Quasar	0000
RCA	0021
Radio Shack	0015, 0315, 0797, 0883
Recoton	0400
Regal	0020, 0259
Regency	0002
Rembrandt	0011
Runco	0000
SL Marx	0040

continued on next page...

PROGRAMMING CABLE CONVERTER OR SATELLITE RECEIVER CONTROL

Setup Codes for Cable Converters (Continued):

Samsung	0144, 0040
Scientific Atlanta	0008, 0477, 0017, 0877
Signal	0015, 0040
Signature	0011
Sprucer	0021
Starcom	0003, 0015
Stargate	0015, 0040, 0797
Starquest	0015
TV86	0063
Tandy	0258
Televue	0040
Timeless	0418
Tocom	0012, 0013
Toshiba	0000
Tusa	0015
Unika	0153, 0022
United Artists	0007
Universal	0153, 0022, 0056, 0191
Viewstar	0063, 0258
Zenith	0000, 0525, 0899
Zentek	0400

Setup Codes for Satellite Receivers:





AlphaStar	0772
Echostar	0775, 1005
Expressvu	0775
General Instrument	0627, 0361, 0869
HTS	0775
Hitachi	0819
Hughes Network	0749
JVC	0775
Jerrold	0627, 0361
Magnavox	0724, 0722
Memorex	0724
Next Level	0869
Panasonic	0701
Philips	0724, 0722
Primestar	0627, 0361
RCA	0566, 0143, 0392, 0855
Radio Shack	0869
Sony	0639
Star Choice	0869
Toshiba	0790
Uniden	0724, 0722
Zenith	0856

PROGRAMMING DVD PLAYER CONTROL

Locate the brand name of your DVD (or LD) player in the *Setup Codes For DVDs (or LDs)* section on the next page, and write it in the following space.

DVD (or LD) Brand: _____

The brands are listed in alphabetical order with the most popular codes listed first. To program DVD (or LD) player control:

1. Turn on your DVD (or LD) player.
2.  On the remote control, press DVD once. Press and hold SET until the LED blinks twice, then release SET. 
NOTE: The remote control will exit programming if more than 10 seconds elapse between key presses.
3. Enter the first four-digit code for your DVD (or LD) player. If you perform this procedure correctly, the LED will blink twice.
NOTE: If the LED emits a long blink, the code is invalid. Repeat steps 2 through 3 and try entering the same code again.
4.  Aim the remote control at your DVD (or LD) player and press POWER once. The unit should turn off. If your DVD (or LD) player remote control does not have a POWER key, press  PLAY. If the DVD (or LD) player does not respond, repeat steps 2-3, trying each code listed for your brand until you find one that works. If the DVD (or LD) player still does not work, try searching for the code (see *Searching For Your Code* on page 23).
5. Write your DVD (or LD) player code in the boxes below for future reference.

--	--	--	--

NOTE: Remember, to use the One For All 4-Device Video Expert remote control to operate your DVD (or LD) player, press DVD first.

PROGRAMMING DVD PLAYER CONTROL (Continued)

Setup Codes for DVD Players:

Denon	0490, 0634
GE	0522
Harman/Kardon	0582
JVC	0558, 0623
Kenwood	0534
Magnavox	0503
Marantz	0539
Mitsubishi	0521
Onkyo	0503, 0627
Optimus	0571
Panasonic	0490, 0632
Philips	0503, 0539
Pioneer	0525, 0571, 0632
Proscan	0522
RCA	0522
Samsung	0573
Sharp	0630
Sherwood	0633
Sony	0533
Technics	0490
Theta Digital	0571
Toshiba	0503
Yamaha	0490, 0545
Zenith	0503, 0591



Setup Codes for LD Players:

Aiwa	0203
Denon	0059, 0172
Funai	0203
Mitsubishi	0059
NAD	0059
Optimus	0059
Panasonic	0204
Pioneer	0059
Quasar	0204
Realistic	0203
Sony	0193, 0201
Technics	0204

SEARCHING FOR YOUR CODE

If your video component does not respond to the One For All 4-Device Video Expert remote control after trying all of the codes listed for your brand, or if your brand is not listed at all, try searching for your code.

For example, to search for a code for your TV:



1. Turn on your TV.
2.  On the remote control, press TV once. Press and hold SET until the LED blinks twice, then release SET.
3.  Enter 9 - 9 - 1. The LED will blink twice.
4.  Aim the remote control at the the TV and slowly alternate between pressing POWER and TV. Stop when the TV turns off.

NOTE: In the search mode, the One For All 4-Device Video Expert remote control will send IR codes from its library to the selected component, starting with the most popular code first.

5.  Press SET once to lock in the code.
6. To search for the codes of your other components, repeat steps 1 through 5, but substitute the appropriate key (i.e., DVD, VCR, or CBL/SAT) for the (DVD/LD, VCR, or Cable/Satellite) component you are searching for.

CHECKING THE CODES

If you have set up the One For All 4-Device Video Expert remote control using the *Searching For Your Code* procedure, you may need to find out which four-digit code is operating your equipment. For example, to find out which code is operating your TV:

1. Turn on your TV.
2.  On the remote control, press TV once. Press and hold SET until the LED blinks twice, then release SET.
3.  Enter 9 - 9 - 0. The LED will blink twice.
4.  To view the code for the first digit, press 1 once. Count the number of LED blinks (e.g., 3 blinks = 3) and write down the number in the left-most TV Code box below.
NOTE: If a code digit is "0", the LED will not blink.
5. Repeat step 4 three more times for remaining digits. Use 2 for the second digit, 3 for the third digit, and 4 for the fourth digit. Finish writing down the code in the TV Code boxes below.
6. To check for the codes of your other components, repeat steps 1 through 5, but substitute the appropriate key (i.e., DVD, VCR, or CBL/SAT) for the (DVD/LD, VCR, or Cable/Satellite) component you are checking. Write down the codes in the appropriate boxes below.

TV Code

--	--	--	--

DVD (or LD) Code

--	--	--	--

VCR Code









--	--	--	--

Cable/Satellite Code

--	--	--	--

PROGRAMMING THE MASTER POWER KEY FOR ALL ON/OFF

With the One For All 4-Device Video Expert, you can program the M. POWER key to turn your TV, VCR, DVD, and Cable (or Satellite) components on and off with the press of one button.

1.  On the remote control, press and hold SET until the LED blinks twice, then release SET.
2.  Enter 9 - 9 - 5. The LED will blink twice.
3.  Press M.POWER once.
4. Enter the following sequence*:
 - a.  Press TV once.
 - b.  Press VCR once.
 - c.  Press DVD once.
 - d.  Press CBL/SAT once.
5.  Press and hold SET until the LED blinks twice, then release SET.
6. Now, when you press M.POWER once, the remote control will direct power to your TV, VCR, DVD (or LD) player, and Cable/Satellite component and leave the remote control in the TV mode.



* *NOTE: If you do not want all of your equipment to power up all of the time, you can shorten step 4 to include only those devices you want to turn on or off. For example, to just power up your TV and DVD (or LD) player, enter the following sequence for step 4:*

- a. Press TV once.
- b. Press DVD once.

Now when you press M.POWER once, the One For All 4-Device Video Expert remote control will only direct power to your DVD (or LD) player and TV, and still leave the remote control in the TV mode.

RE-ASSIGNING DEVICE KEYS

The One For All 4-Device Video Expert remote control can be set up to control a second TV or VCR, or any combination of four video components. For example, to have the unit control a TV, a Cable Converter, and *two* VCRs, you will need to re-assign the unused DVD key to operate the second VCR as follows:

1.  On the remote control, press and hold SET until the LED blinks twice, then release SET.
2.  Enter 9 - 9 - 2. The LED will blink twice.
3.  Press VCR once, then press DVD once. The LED will blink twice.
4. Program the DVD key as a second VCR. See *Programming VCR Control* on page 12.

To re-assign other device keys, repeat steps 1 through 4 by substituting the key sequence from the following chart for a desired component:

To Re-Assign	Perform Key Sequence
VCR as 2nd TV key:	SET - 9 - 9 - 2 - TV - VCR
VCR as 2nd DVD key:	SET - 9 - 9 - 2 - DVD - VCR
VCR as 2nd Cbl/Sat key:	SET - 9 - 9 - 2 - CBL/SAT - VCR
VCR back to VCR:	SET - 9 - 9 - 2 - VCR - VCR
DVD as 2nd TV key:	SET - 9 - 9 - 2 - TV - DVD
DVD as 2nd VCR key:	SET - 9 - 9 - 2 - VCR - DVD
DVD as 2nd Cbl/Sat key:	SET - 9 - 9 - 2 - CBL/SAT - DVD
DVD back to DVD:	SET - 9 - 9 - 2 - DVD - DVD
CBL/SAT as 2nd TV key:	SET - 9 - 9 - 2 - TV - CBL/SAT
CBL/SAT as 2nd DVD key:	SET - 9 - 9 - 2 - DVD - CBL/SAT
CBL/SAT as 2nd VCR key:	SET - 9 - 9 - 2 - VCR - CBL/SAT
CBL/SAT back to CBL/SAT:	SET - 9 - 9 - 2 - CBL/SAT - CBL/SAT



Upon completion of a re-assignment, the LED will blink twice to confirm your selection. At that time, you will also need to program the remote control to control the new component (see previous sections on *Programming VCR Control*, *Programming Cable Converter or Satellite Receiver Control*, or *Programming DVD Player Control*).

CHANGING VOLUME LOCK



The One For All 4-Device Video Expert remote control is preset to control the volume of a component through your TV.

If your TV is not remote controllable, or if you would like the volume to be controlled by a different component, you can change the Volume Lock setting to control a volume through a non-associated mode (e.g., through the *cable* in the TV mode).



To change Volume Lock to the CBL/SAT mode:

1.  On the remote control, press and hold SET until the LED blinks twice, then release SET.
2.  Enter 9 - 9 - 3 and then press CBL/SAT once. The LED will blink twice.

3. Now, whenever you press VOL +, VOL -, or MUTE on the remote control, the volume will be controlled by your Cable Converter or Satellite Receiver.

To change Volume Lock to the VCR mode:



1.  On the remote control, press and hold SET until the LED blinks twice, then release SET.
2.  Enter 9 - 9 - 3 and then press VCR once. The LED will blink twice.

3. Now, whenever you press VOL +, VOL -, or MUTE on the remote control, volume will be controlled by your VCR.

To change Volume Lock to the DVD mode:



1.  On the remote control, press and hold SET until the LED blinks twice, then release SET.
2.  Enter 9 - 9 - 3 and then press DVD once. The LED will blink twice.

3. Now, whenever you press VOL +, VOL -, or MUTE on the remote control, volume will be controlled by your DVD (or LD) player.

CHANGING VOLUME LOCK (Continued)

To change Volume Lock back to the TV mode:

1.  On the remote control, press and hold SET until the LED blinks twice, then release SET.
2.  Enter 9 - 9 - 3 and then press TV once.
 The LED will blink twice.
3. Now, whenever you press VOL +, VOL -, or MUTE on the remote control, volume will be again controlled by your TV.

To Unlock Volume Lock:

1.  On the remote control, press and hold SET until the LED blinks twice, then release SET.
2.  Enter 9 - 9 - 3 and then press VOL+ once.
 The LED will blink twice.

USING THE MENU KEY

On your One For All 4-Device Video Expert remote control, the MENU key works just like the MENU key of your original remote control and allows you to access the on-screen menu of the component you have selected (e.g., TV, VCR, DVD, or CBL/SAT).

When you press MENU, the VOL+, VOL-, CH+, and CH- keys will allow you to navigate and adjust the on screen menu settings just like you would with your original remote control. Also, the MUTE key becomes the Menu Select key.









To exit out of the Menu mode, press MENU or EXIT to return to normal operation.

USING KEYMOVER

The One For All 4-Device Video Expert remote control includes a *Keymover* feature that allows you to map (or copy) keys from one mode (i.e., source mode) to another (i.e., destination mode).

NOTE: The following keys cannot be mapped: TV, DVD, VCR, CBL/SAT, SET, M.POWER, V.CONFIG, and macro keys F1 ~ F4.

For example, if your VCR does not have volume control, you can map the volume and mute keys from the TV mode to the VCR mode as follows:

1.  On the remote control, press and hold SET until the LED blinks twice, then release SET.
2.  Enter 9 - 9 - 4.
3.  For the source mode, press TV once.
4.  For the source key, press VOL + once.
5.  For the destination mode, press VCR once.
6.  For the destination key, press VOL + once. The LED will blink twice indicating the key-moved sequence is correct.
7.  Repeat steps 1 through 6 twice more, substituting VOL - and MUTE as source and destination keys in steps 4 and 6.

Upon completion of the above procedure, you can now use your One For All 4-Device Video Expert remote control to control the TV's volume and mute in the VCR mode, as well as in the TV mode.

USING MACROS

With programming, the F1 through F4 keys on your One For All 4-Device Video Expert remote control can be setup to perform repetitive, time-consuming operations for easy, convenient access through the press of a single key.

The F keys are ideal for home theater operations, setting a favorite channel, adding to multiple component uses, guide steps, or other multiple functions you would like to control with one key press.





For the optimum in individual customization, you can define and program a sequence of events, since each F key can hold up to three macros or 12 key presses total. Below are a few examples to get you started.

NOTE: Programming a new macro over an existing one will erase the original macro.

Programming A Favorite Channel

With so many channels available through your cable system or satellite provider, you can program a macro that directly selects a favorite channel with one key press.

For example, let's assume your favorite cable programs are on channel 71. Use the following instructions to program an F key for direct access of this channel:

1.  On the remote control, press and hold SET until the LED blinks twice, then release SET.
2.  Enter 9 - 9 - 5. The LED will blink twice.
3.  Select an open F key (e.g., F1) and press it once.
4.  Press TV once.
5.  Enter the channel number, 7 - 1.











NOTE: If you have access to over 100 channels, enter in 071.

6.  Press and hold SET until the LED blinks twice, then release SET.

Now when you press F1, you will instantly see cable channel 71 on your TV set.





Programming A Secondary Master Power Key With Instant Channel Selection

Just like the M.POWER key, any F key can be programmed to turn on and off your equipment. As an example, you want your child to be able to easily turn on the equipment and select a favorite premium channel. You can setup a sequence using two macros on one F key – the first macro will turn on the TV and tune it to channel 3, and the second macro will turn on the Cable Box and tune it to a desired channel (e.g., 11).

1.  On the remote control, press and hold SET until the LED blinks twice, then release SET.
2.  Enter 9 - 9 - 5. The LED will blink twice.
3.  Select an open F key (e.g., F2) and press it once.
4.  Enter the following sequence:
 TV,
 POWER, and
 0 - 3 (or 0 - 0 - 3 if access is over 100 channels)
5.  Press and hold SET until the LED blinks twice, then release SET.
6. Repeat steps 1 through 5, but this time in step 4 enter the following sequence:
 CBL/SAT,
 POWER, and
 1 - 1 (or 0 - 1 - 1 if access is over 100 channels)

Now when you press F2 once, the TV will turn on and tune to channel 03. When you press F2 once again, the Cable Box will turn on and tune to channel 11.

Clearing A Macro

1.  On the remote control, press and hold SET until the LED blinks twice, then release SET.
2.  Enter 9 - 9 - 5. The LED will blink twice.
3.  Select an F key (e.g., F1~ F4) you want to clear and press it once.
4.  Press and hold SET until the LED blinks twice, then release SET.

USING THE VIDEO CONFIGURATION MODE

The One For All 4-Device Video Expert remote control includes a powerful *Video Configuration* feature that allows you to combine the most used functions of your Audio/Video equipment into one V.CONFIG mode. The features you can combine are organized into five groups and can be defined by specific modes as follows:



Function Groups

- *Function Group 1* – Transport Keys (Play, Stop, Fast Forward, Rewind, Pause, Record, Forward Scan, and Rewind Scan)
- *Function Group 2* – Volume Keys (Volume Up, Volume Down, and Mute)
- *Function Group 3* – Channel Keys (Channel Up, Channel Down, Digits 0-9, Enter, Previous Channel, Sleep, and Display)
- *Function Group 4* – Menu Keys (Menu, Up, Down, Left, Right, and Select)
- *Function Group 5* – PIP Keys (Picture-In-Picture, Swap, and Move)







Component (Mode) Groups

- *Component Group 1* – VCR and DVD
- *Component Group 2* – TV, VCR, and Cable/Sat
- *Component Group 3* – TV, VCR, and Cable/Sat
- *Component Group 4* – TV, VCR, Cable/Sat, and DVD
- *Component Group 5* – TV, VCR, and Cable/Sat

To enable the *Video Configuration* feature, you'll need to perform the following programming sequence:





1.  On the remote control, press V.CONFIG once.
2.  Press and hold SET until the LED blinks twice, then release SET.
3.  Enter 9 - 7 - 9. The LED will blink twice.

At this point, you'll assign *Component Groups* to *Function Groups* up to five times, depending on how many combinations you need. You can perform any of the following steps in any order, as long as you finish the sequence with step 9.

4.  Select a key from *Component Group 1* (i.e., VCR or DVD) and press it once. Press PLAY to assign *Function Group 1* (i.e., the transport keys). The LED will blink twice.
5.  Select a key from *Component Group 2* (i.e., TV, VCR, or CBL/SAT) and press it once. Press VOL+ to assign *Function Group 2* (i.e., the volume keys). The LED will blink twice.
6.  Select a key from *Component Group 3* (i.e., TV, VCR, or CBL/SAT) and press it once. Press CH+ to assign *Function Group 3* (i.e., the channel keys). The LED will blink twice.
7.  Select a key from *Component Group 4* (i.e., TV, DVD, VCR, or CBL/SAT) and press it once. Press MENU to assign *Function Group 4* (i.e., the menu keys). The LED will blink twice.
8.  Select a key from *Component Mode Group 5* (i.e., TV, VCR, or CBL/SAT) and press it once. Press PIP to assign *Function Group 5* (i.e., the PIP keys). The LED will blink twice.
9.  To lock in the *Video Configuration*, press SET until the LED blinks twice, then release SET.

An Example Video Configuration









From one mode, you would like to play your DVD, use the Volume control on the TV, change channels on your Cable Box, control the Menu on the Cable Box, and use the PIP feature of your TV. To program this *Video Configuration* you would perform the following steps:

1.  On the remote control, press V.CONFIG once.
2.  Press and hold SET until the LED blinks twice, then release SET.
3.  Enter 9 - 7 - 9. The LED will blink twice.
4.  Press DVD once and then press PLAY. The LED will blink twice.

...continued on next page

USING THE VIDEO CONFIGURATION MODE

An Example Video Configuration (Continued)

5.  Press TV once and then press VOL+. The LED will blink twice.

6.  Press CBL/SAT once and then press CH+. The LED will blink twice.

7.  Press CBL/SAT once and then press MENU. The LED will blink twice.

8.  Press TV once and then press PIP. The LED will blink twice.

9.  To lock in the *Video Configuration*, press SET until the LED blinks twice, then release SET.

TROUBLESHOOTING

- PROBLEM:** LED does not blink when you press a key.
SOLUTION: Replace the batteries with two (2) new AA alkaline batteries (see page 7).
- PROBLEM:** LED blinks when you press a key, but home entertainment component does not respond.
SOLUTION: Make sure you are aiming the remote control at your home entertainment component and that you are within 15 feet of the component you are trying to control.
- PROBLEM:** The remote control does not control home entertainment components or commands are not performing properly.
SOLUTION: Try all listed codes for the component brand being set up. Make sure all components can be operated with an infrared remote control.
- PROBLEM:** TV/VCR combo does not respond properly.
SOLUTION: Use the VCR codes for your brand. Some combo units may require both a TV code and a VCR code for full operation (see page 16).
- PROBLEM:** No volume on a second TV.
SOLUTION: Follow instructions in *Changing Volume Lock* (see page 27).
- PROBLEM:** CH+ , CH- , and PREV.CH do not work for your RCA TV.
SOLUTION: Due to RCA design (1983-1987), only the original remote control will operate these functions.
- PROBLEM:** Changing channels does not work properly.
SOLUTION: If original remote control required pressing ENTER to change channels, press ENTER on the remote control after entering a channel number.
- PROBLEM:** Tried "Search Method" and still could not find a working code.
SOLUTION: For help, call our technical support group at 1-330-405-8608 on any business day, between 9 A.M. and 5 P.M., EST.
- PROBLEM:** Remote control does not turn on Sony or Sharp TV/VCR Combo.
SOLUTION: For power on, these products require programming TV codes on the remote control. For Sony, use TV code 0000 and VCR code 0032. For Sharp, use TV code 0093 and VCR code 0048.

ADDITIONAL INFORMATION

The One For All 4-Device Video Expert remote control does not have any user-serviceable parts. Opening the case, except for the battery cover, may cause permanent damage to your remote control.

©2000 by Universal Electronics Inc. No part of this publication may be reproduced, transmitted, transcribed, stored in any retrieval system, or translated to any language, in any form or by any means, electronic, mechanical, magnetic, optical, manual, or otherwise, without the prior written permission of Universal Electronics Inc. One For All® is a registered trademark of Universal Electronics Inc.

Part No. URC4080

7/00

ONE
FOR ALL